

Návod na inštaláciu

Kovový zahradní domček

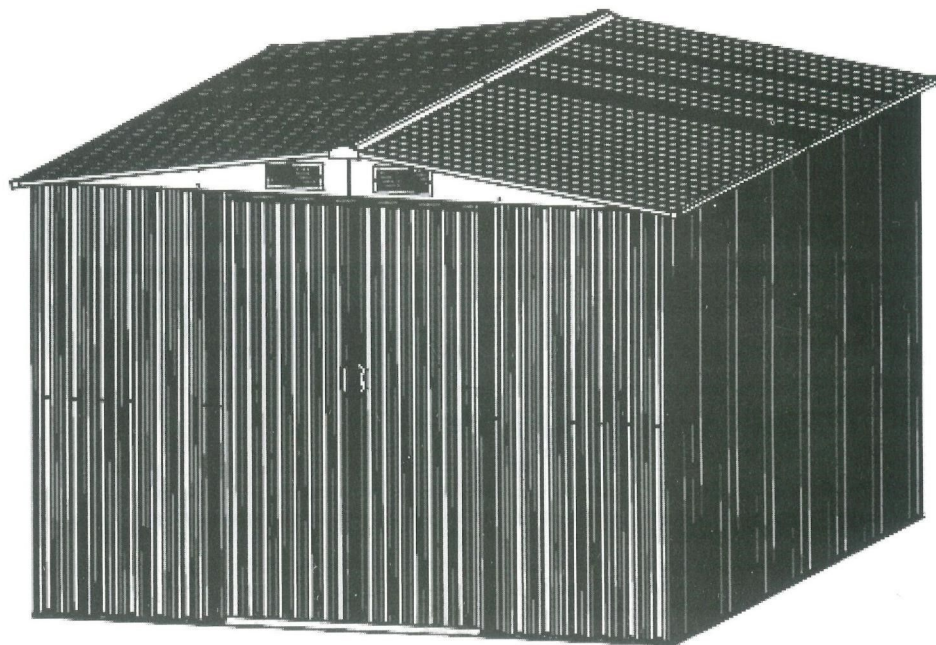

Montáž trvá 5-6 hodín pre 2-3 osoby
(závisí od skúseností staviteľa)

Pozor! Pred začatím montáže si pozorne prečítajte pokyny. Dodržujte prosím prísne pokyny! Pred začatím montáže skontrolujte, či sú diely kompletne! Aby ste predišli možným zraneniam, noste prosím ochranné pomôcky!

PLÁNOVANIE

Tímová práca – Ak je to možné, na montáži budovy by sa mali zúčastniť dvaja alebo viacerí ľudia. Je potrebné, aby jedna osoba umiestnila diely alebo panely podľa plánov, zatiaľ čo druhá osoba pripraví skrutky a nástroje.

Výber a príprava miesta:

Pred inštaláciou je potrebné vybrať správne miesto na umiestnenie domu. Najvhodnejšia je rovná a dobre priepustná pôda.











- Nezabudnite, že pri inštalácii budete potrebovať dostatok miesta! Uistite sa, že máte dostatok miesta na otvorenie vchodových dverí, okolo domu je dostatok miesta, aby ste mohli pripevniť upevňovacie skrutky na domček zvonku.
- Pred montážou je potrebné vytvoriť základ domu a pripraviť upevňovací systém.











Pri manipulácii s rôznymi kusmi buďte opatrní, pretože niektoré predmety môžu mať ostré rohy. Počas inštalácie alebo údržby noste ochranné rukavice, odev s dlhými rukávami a ochranné okuliare.

Buďte opatrní pri manipulácii s nástrojmi! Ak používate elektrické náradie, oboznámte sa jeho používaním a dodržiavajte bezpečnostné predpisy! Na mieste inštalácie by mali byť iba odborníci. Oblasť by mala byť uzavretá, aby sa predišlo nehodám v dôsledku neopatrnosti.

Ak niektorá časť chýba, nezačínajte inštalovať kryt. Dom ponechaný nedokončený alebo nezabezpečený môže vo veternom počasí ľahko spôsobiť škody a poškodiť môže aj samotná stavba.

Zoznam položiek





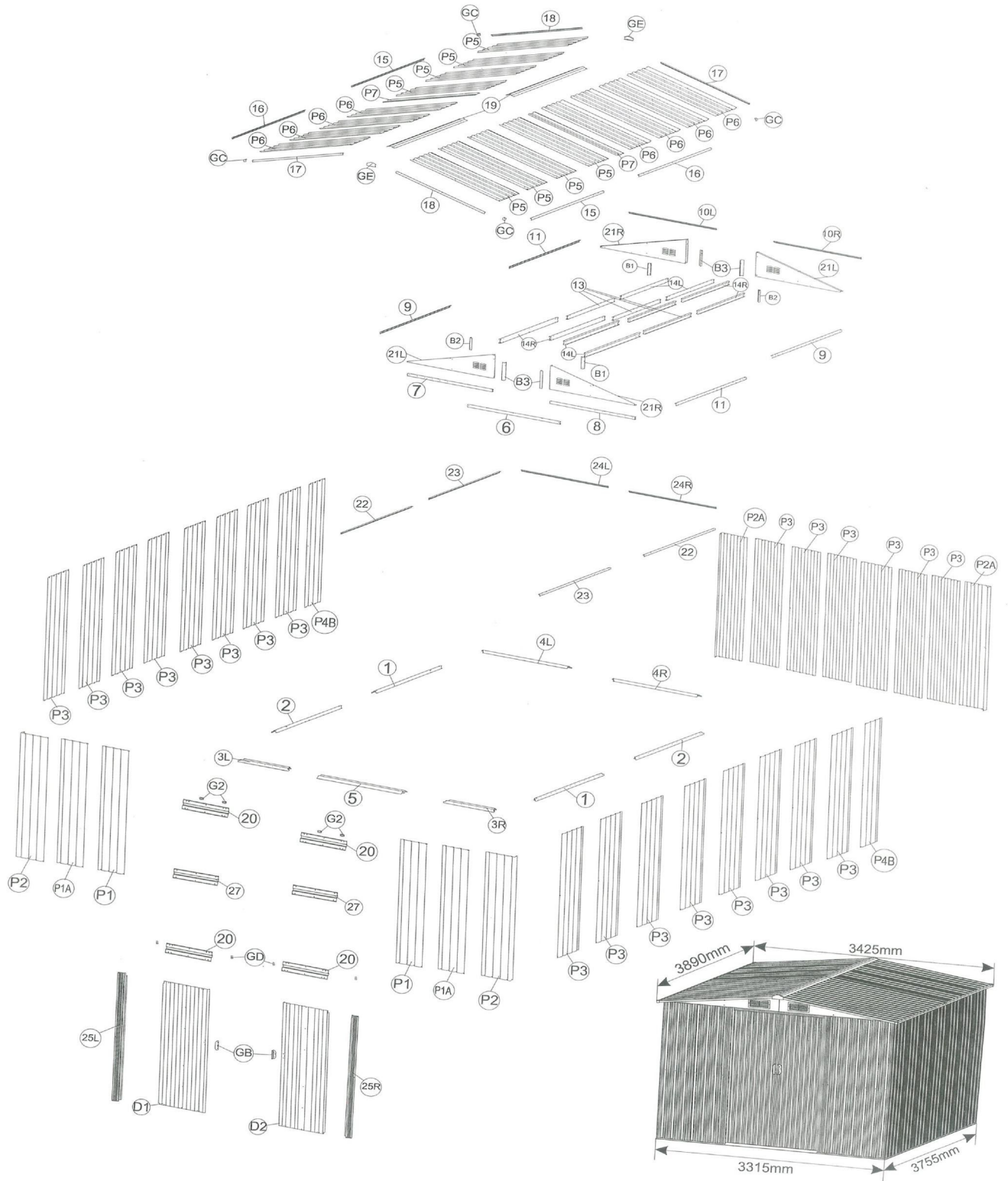

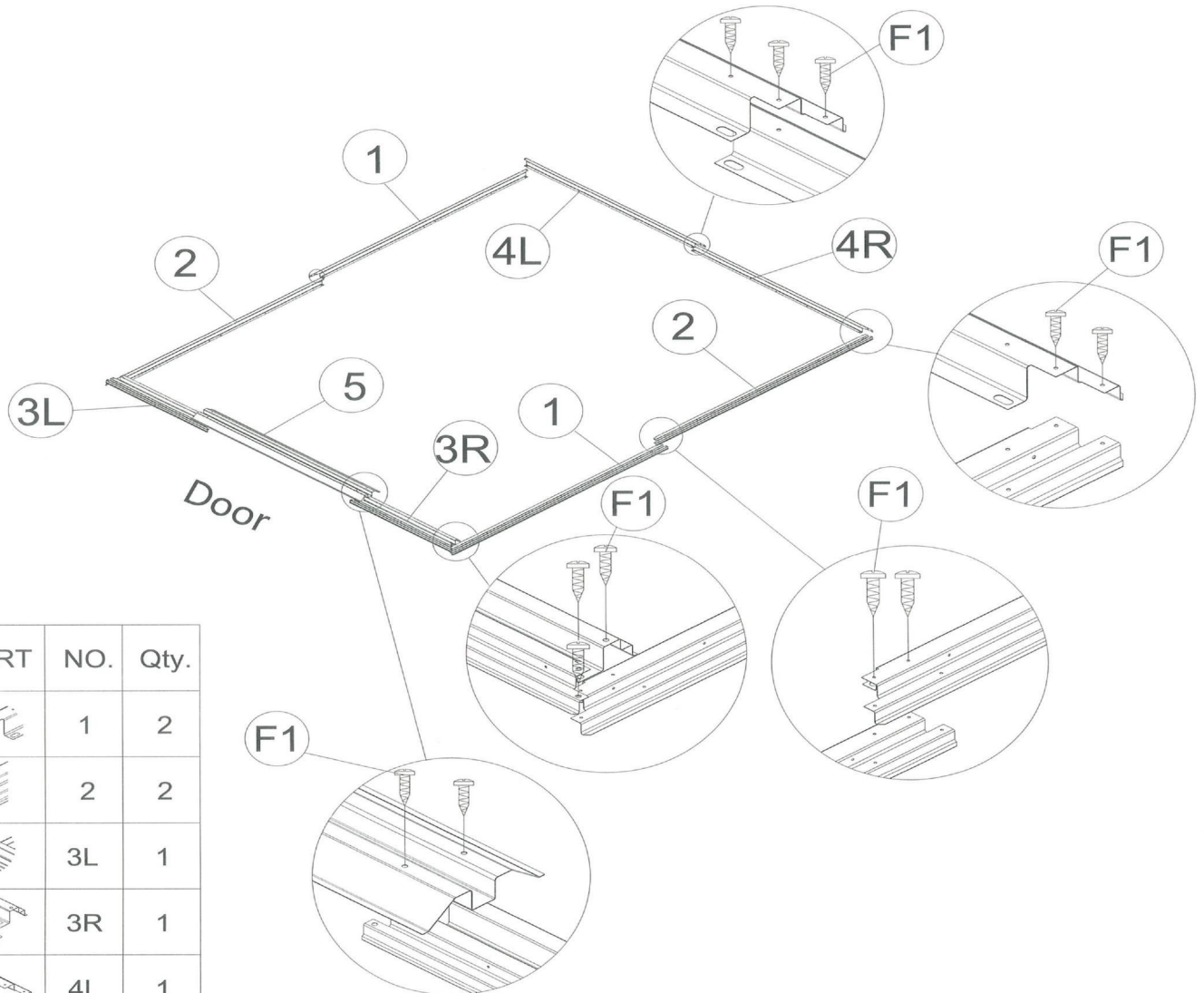

NO	PART	LENGTH	QTY
21L		1752mm	2
21R			2
25L		1650mm	1
25R			1
P1		1650mm	2
P1A		1650mm	2
P2		1650mm	2
P2A		1650mm	2
P3		1650mm	4
P4B		1650mm	2
D1		1640mm	1
D2			1

NO	PART	LENGTH	QTY
F1			541
F2			140
F3			8
G2			4
GB			2
GC			4
GF			4
GD			4
GE			2
S2			560
S1			300



1. Zmontujte spodné tyče (1 až 4R) pomocou skrutiek označených F1. Potom umiestnite vstupný spojovací kanál (5) na vrch (3L) a (3R). Pripevnite ho k základni pomocou skrutiek označených F1, ako je znázornené na obrázku nižšie. Uistite sa, že rohy základne sú v perfektnom pravom uhle.



PART	NO.	Qty.
	1	2
	2	2
	3L	1
	3R	1
	4L	1
	4R	1
	5	1
	F1	24



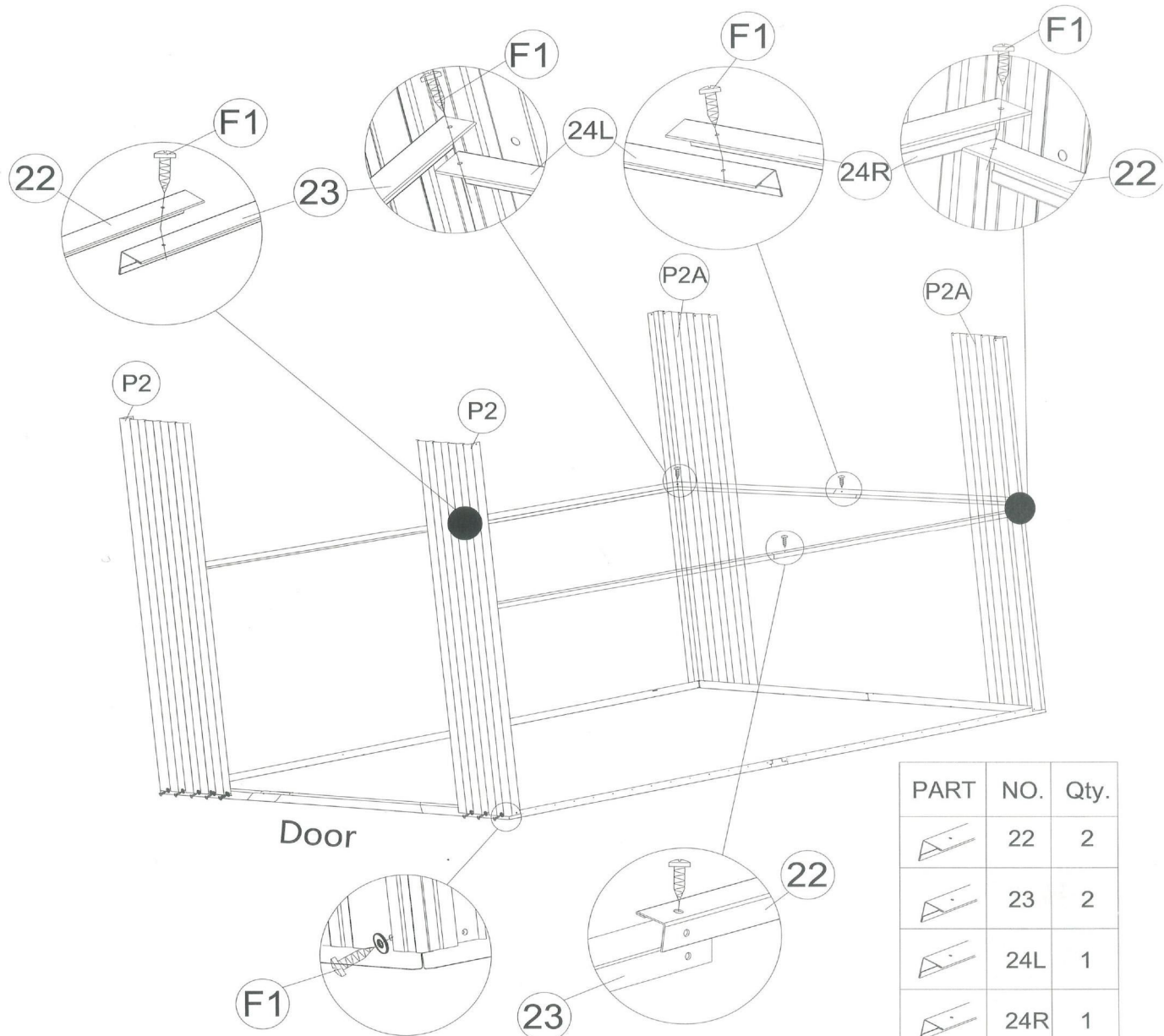

Pripevnite sténové panely k základnému rámu pomocou F1+S2. Pripevnite 22, 23, 24L a 24R na sténový panel. Pomocou F1+S2. Pripojte 22, 23, 24L a 24R iba pomocou F1.

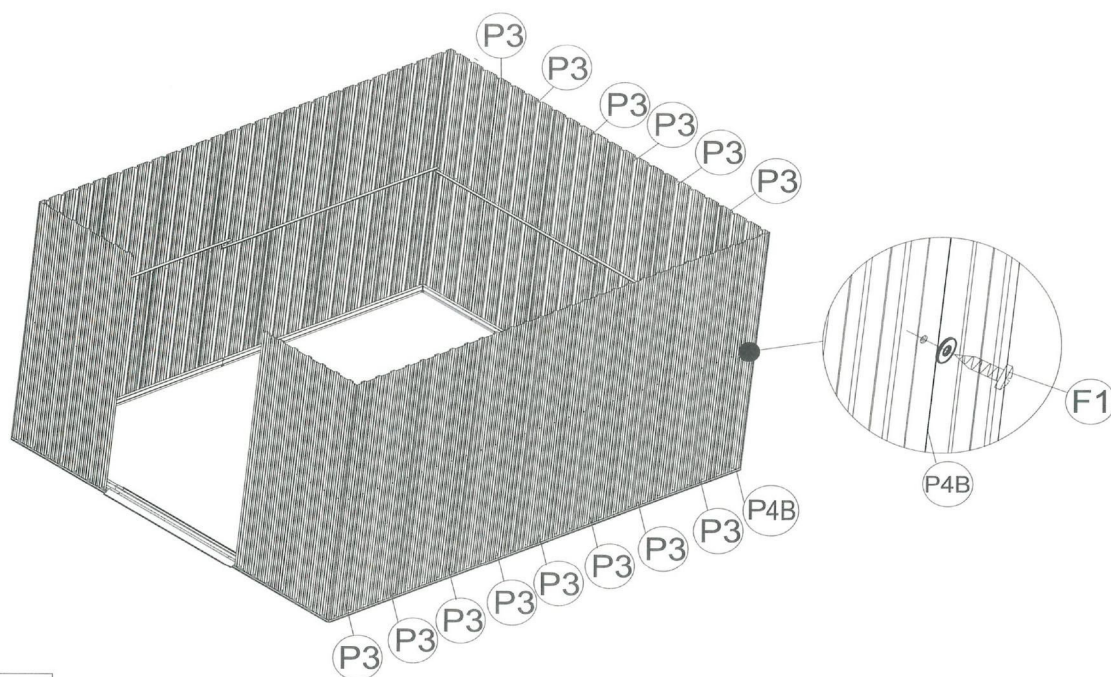

PART	NO.	Qty.
	22	2
	23	2
	24L	1
	24R	1
	P2	2
	P2A	2
	F1	31

Pripevnite stenový panel k základnému rámu pomocou F1+S2.
 Poradie: pravá - zadná - ľavá - predná



PART	NO.	Qty.
	P1	2
	P1A	2
	P3	22
	P4B	2
	F1	193

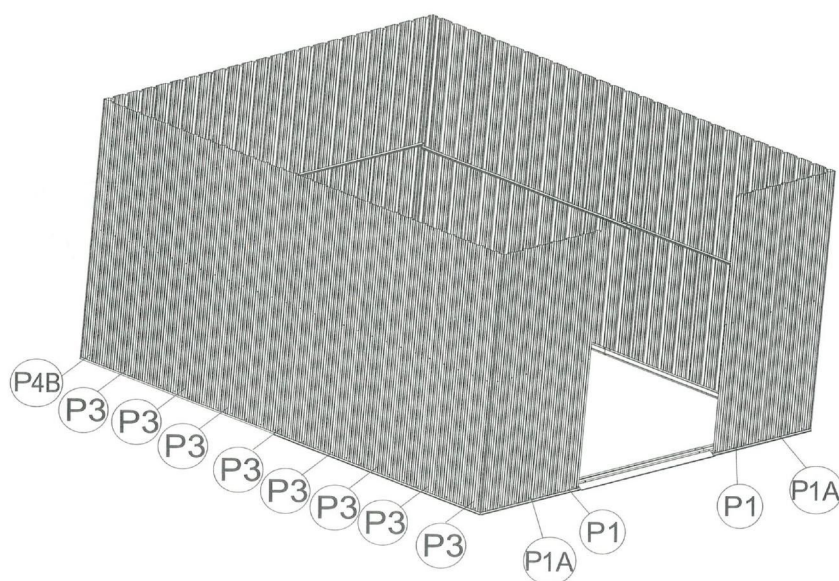

Pripojte 7 a 8 k 6 pomocou F1. Začnite s dvomi otvormi na skrutky strede hornej strany podľa obrázku 6. Zasuňte 4 G2 do kanálov 7 a 8. Akonáhle to urobíte, budú viditeľné otvory pre skrutky G2.

7.

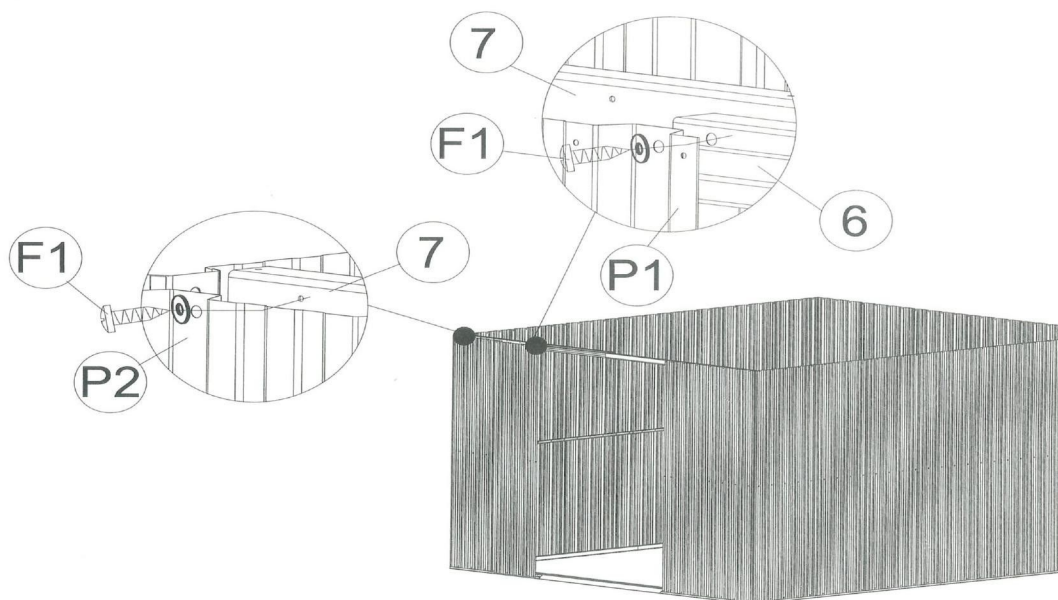
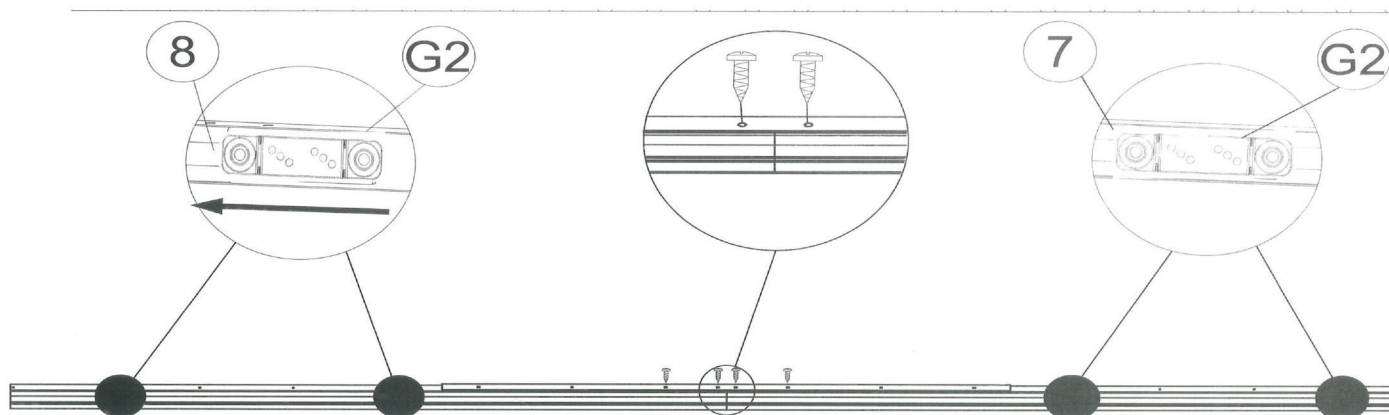

PART	NO.	Qty.
	6	1
	7	1
	8	1
	G2	4
	F1	12

Umiestnite horné rohové tyče 9, 10L, 10R a 11 na vrch stenového panelu. Zarovnajte polohu skrutiek a upevnite ich skrutkami označenými F1.

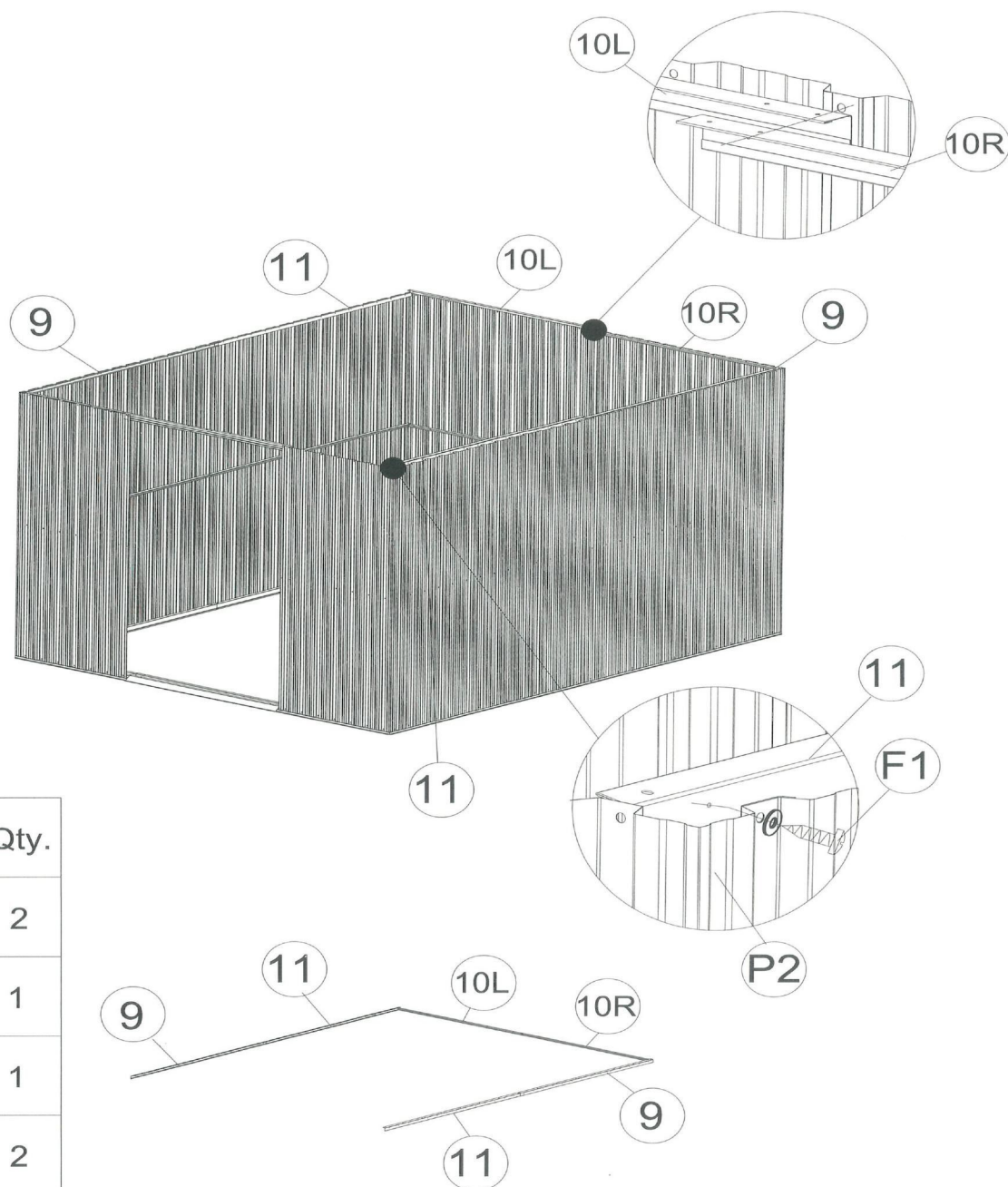

Poznámka: Prvky by sa mali navzájom prekrývať.

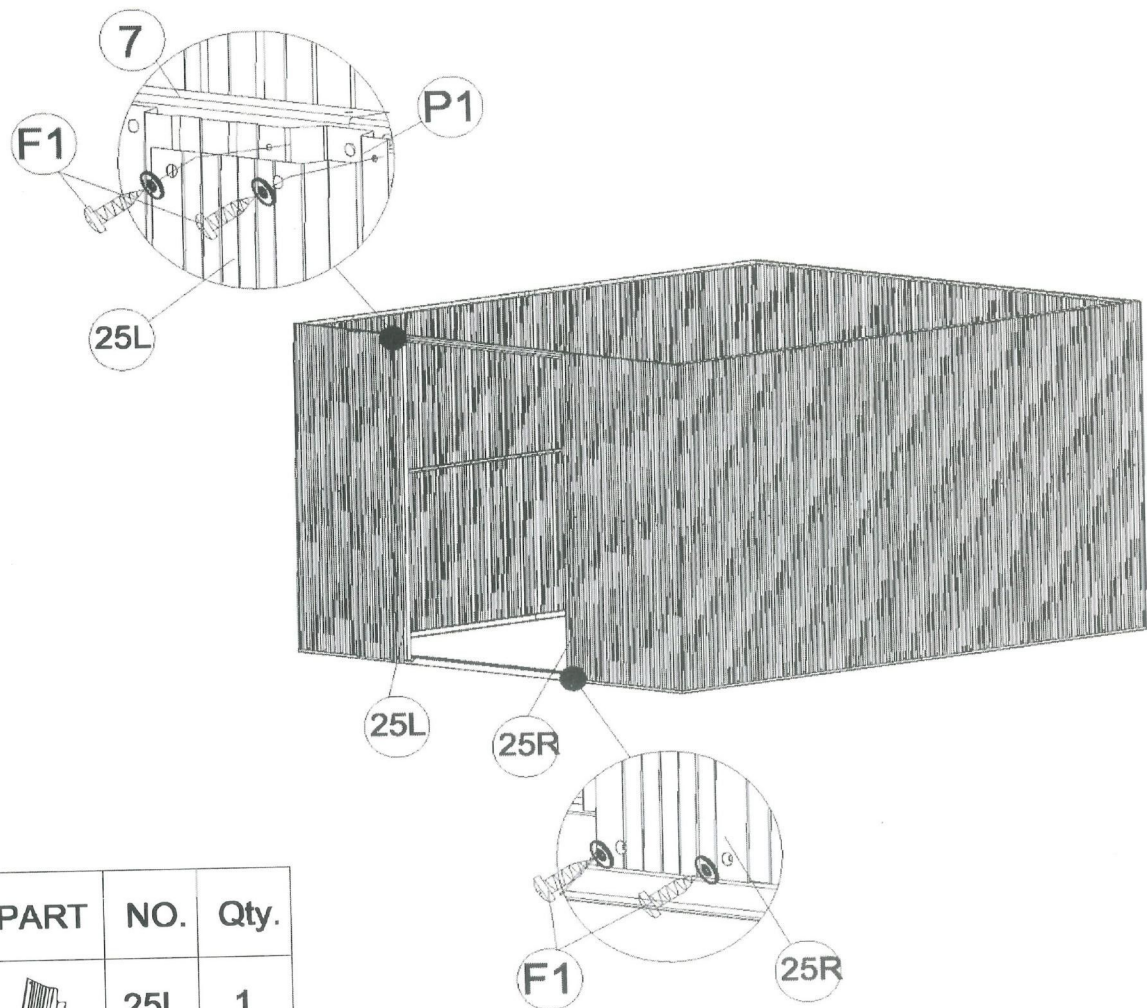

PART	NO.	Qty.
	9	2
	10L	1
	10R	1
	11	2
	F1	103

Umiestnite tyč ľavých dverí 25L a 25R na hornú časť základnej tyče 3L
 Pripevnite tyč dverí pomocou skrutiek 25L F1. Opakujte postup pre
 pravú zárubňu dverí. (25R)



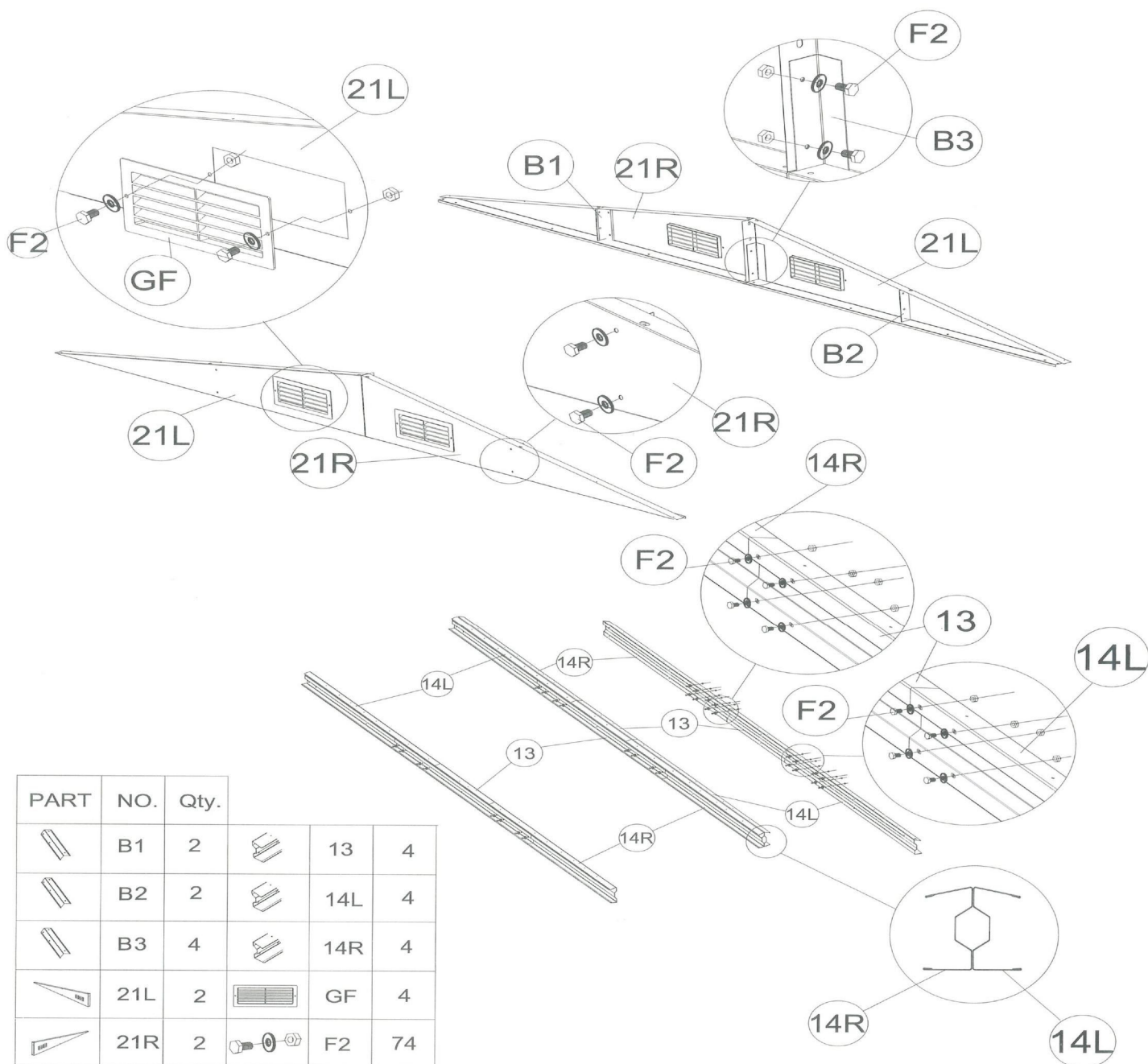

PART	NO.	Qty.
	25L	1
	25R	1
	F1	12

Pripojte B1 a GF k 21L a 21R pomocou F2. Zostavte položky 13, 14R pomocou F2.



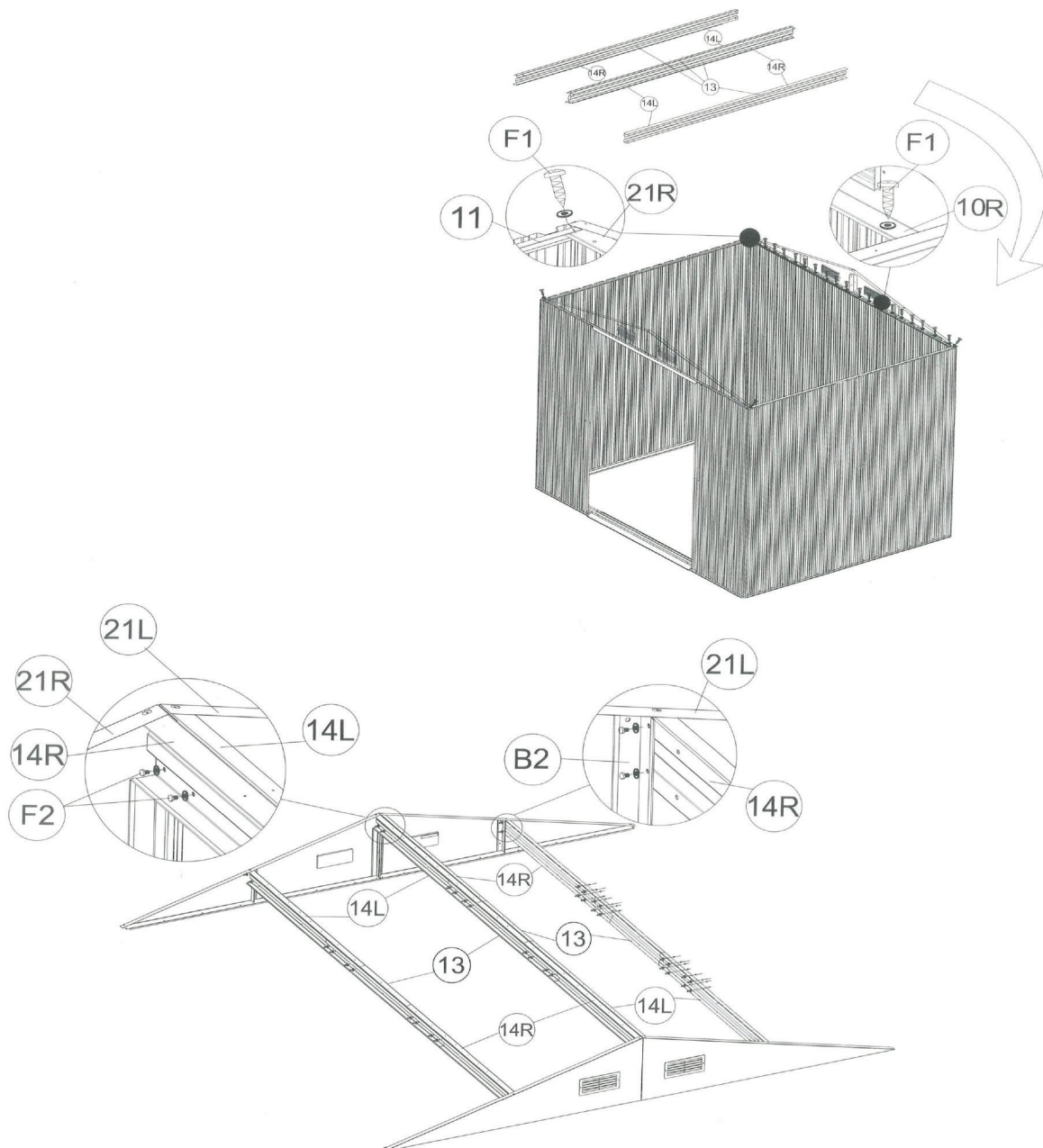



Umiestnite zmontované 21L+21R na vrch 7,8 vpredu a 10L, 10R vzadu.
 Pripevnite 21L+21R k búde skrutkou F1.
 Zmontovaný 13+14L+14R pripevnite k zmontovanému 21L+21R skrutkou F2.

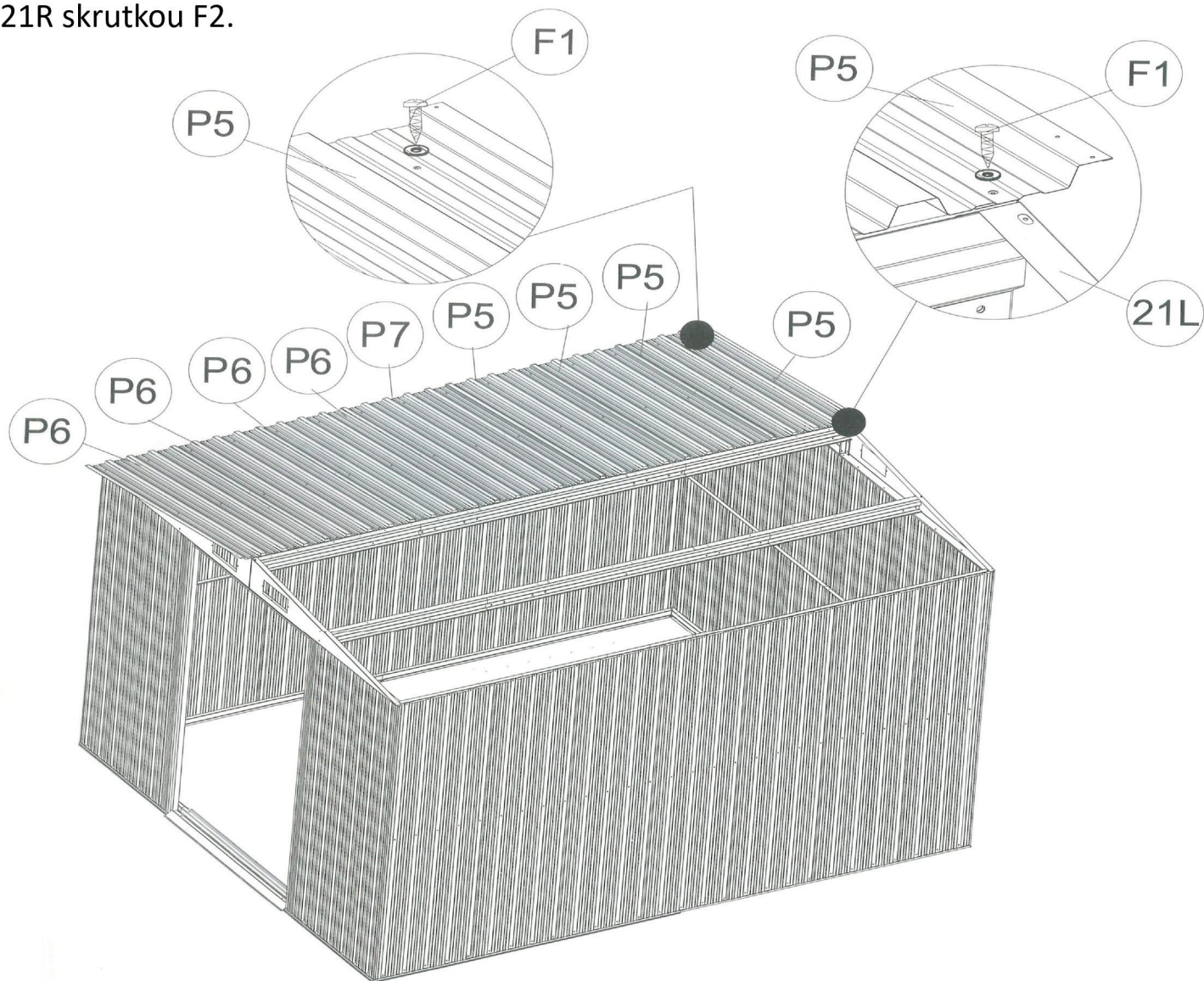

PART	NO.	Qty.
	F1	36
	F2	16





Umiestnite zmontované 21L+21R na vrch 7,8 vpredu a 10L, 10R vzadu. Pripevnite 21L+21R k búde skrutkou F1. Zmontovaný 13+14L+14R pripevnite k zmontovanému 21L+21R skrutkou F2.

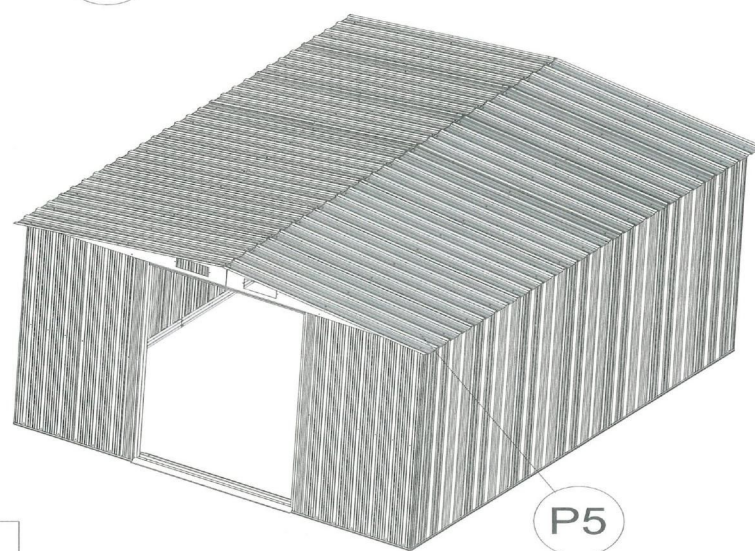
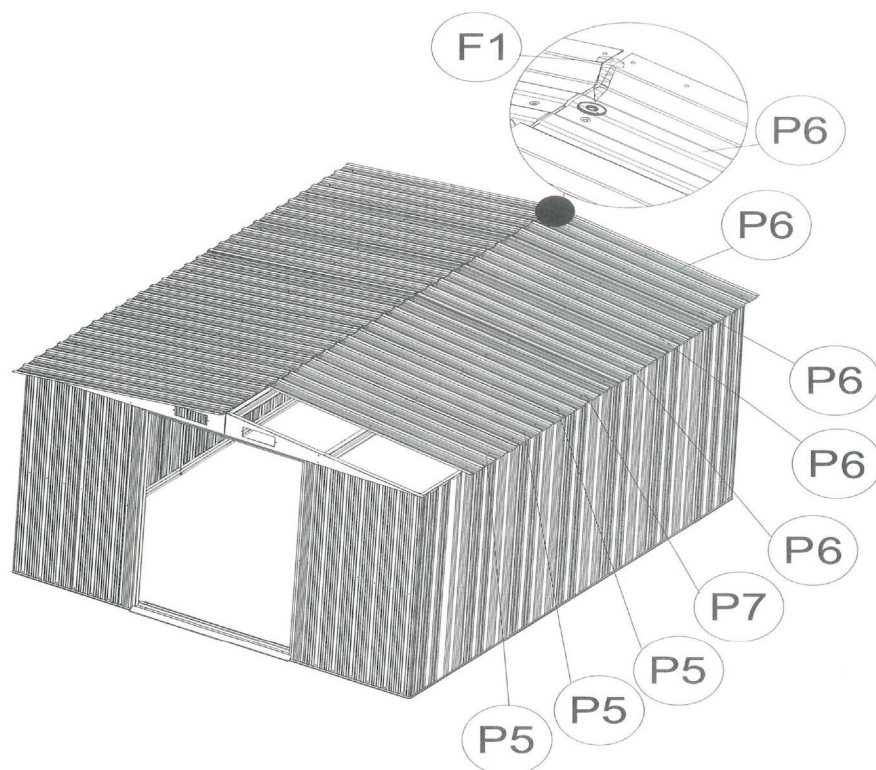

PART	NO.	Qty.			
	P5	4			
	P6	4			
	P7	1		F1	54







Umiestnite strešné panely P5, P6 a P7 na vrchné panely sedlovej strechy a strešné podpery. Zarovnajte otvory pre skrutky a zaistite ich skrutkou F1.

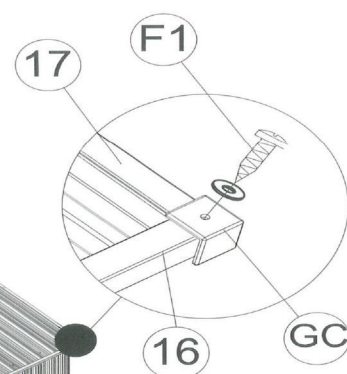
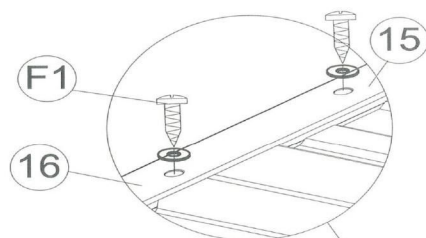
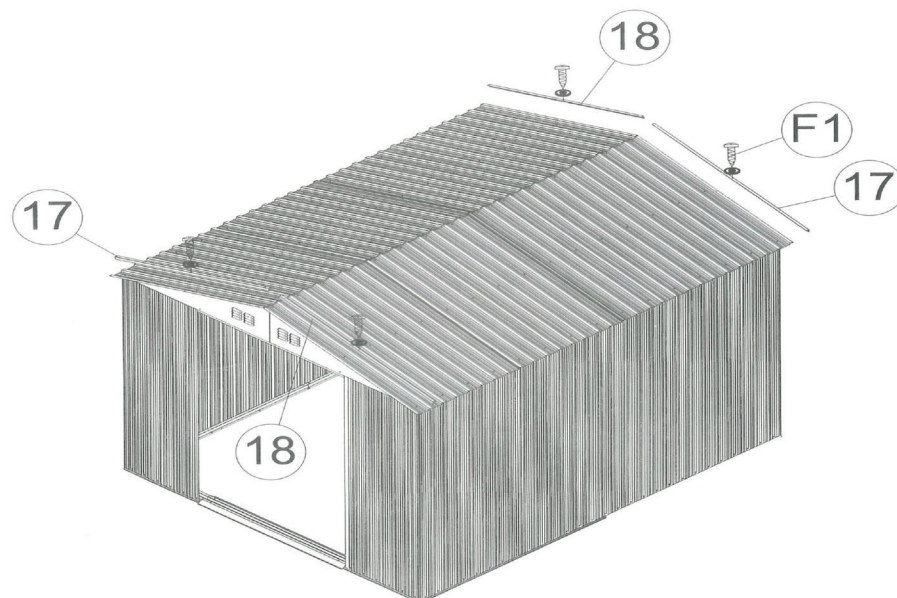

PART	NO.	Qty.			
	P5	4			
	P6	4			
	P7	1		F1	54

Namontujte 15, 16 a pripevnite strešné panely 17, 18 skrutkami F1 s podložkami. Potom položte 4 kusy GC na spoje strechy a pripevnite ich skrutkami F1 s podložkami.



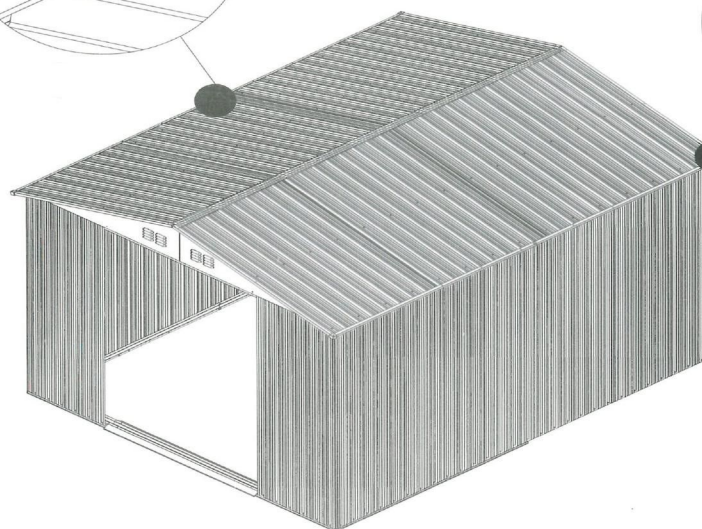

PART	NO.	Qty.
	15	2
	16	2
	17	2
	18	2
	GC	4
	F1	18

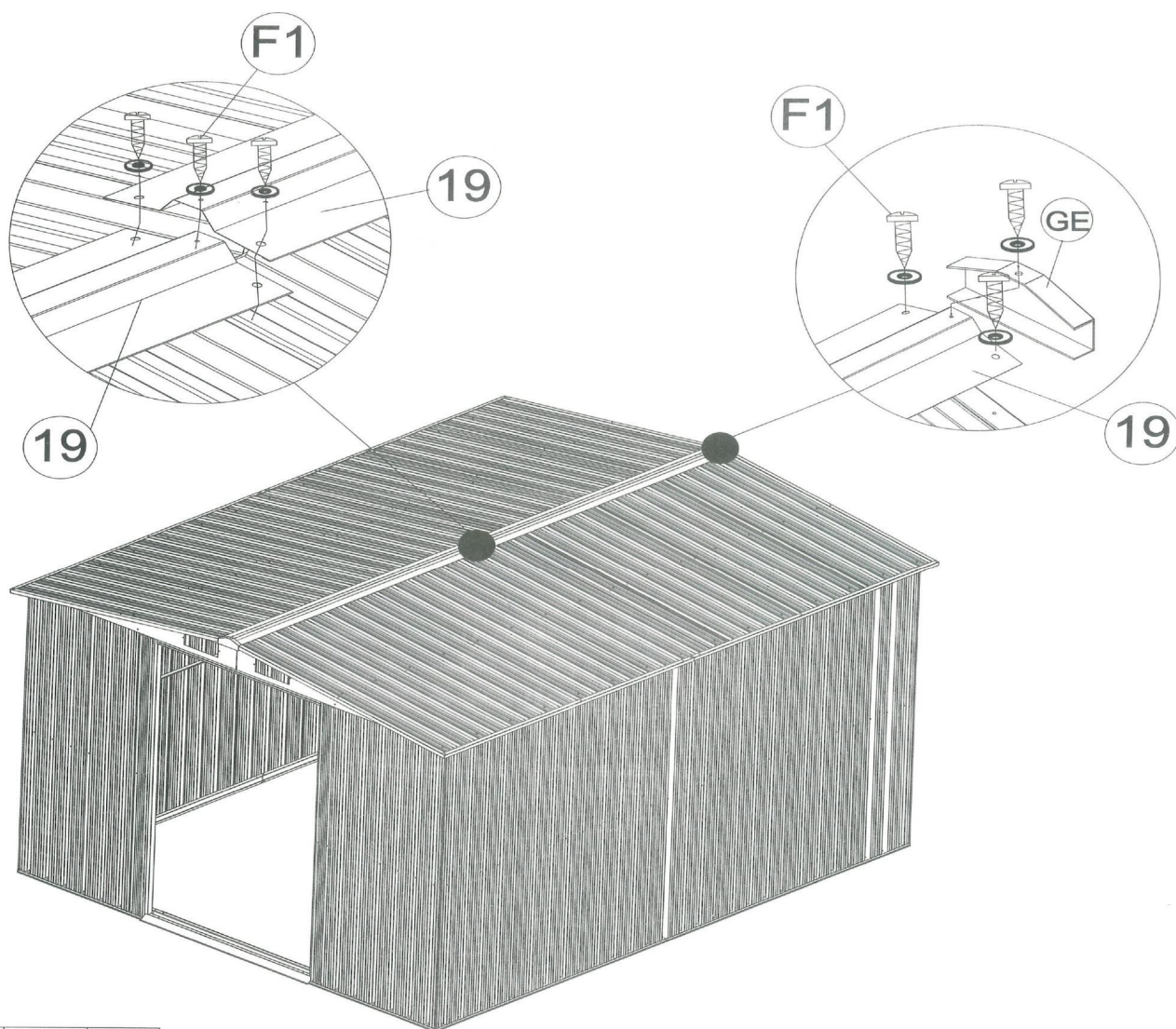

Umiestnite dva stredy 19 zastrešenia na vrch strešných panelov. Zarovnajte prvky a zaistite ich pomocou podložiek a skrutiek F1. Potom nasuňte uzáver GE na oba konce hrebeňa strechy a zaistite.



PART	NO.	Qty.
	19	2
	GE	2
	F1	9

Namontujte tyč dverí 20 na panely dverí D1 a D2 a zaistite ich tyčou 27. Potom nainštalujte spodný posúvač GD na tyč dverí 20 na oboch spodných okrajoch. Upevnite ich skrutkou F2 a maticou s podložkou

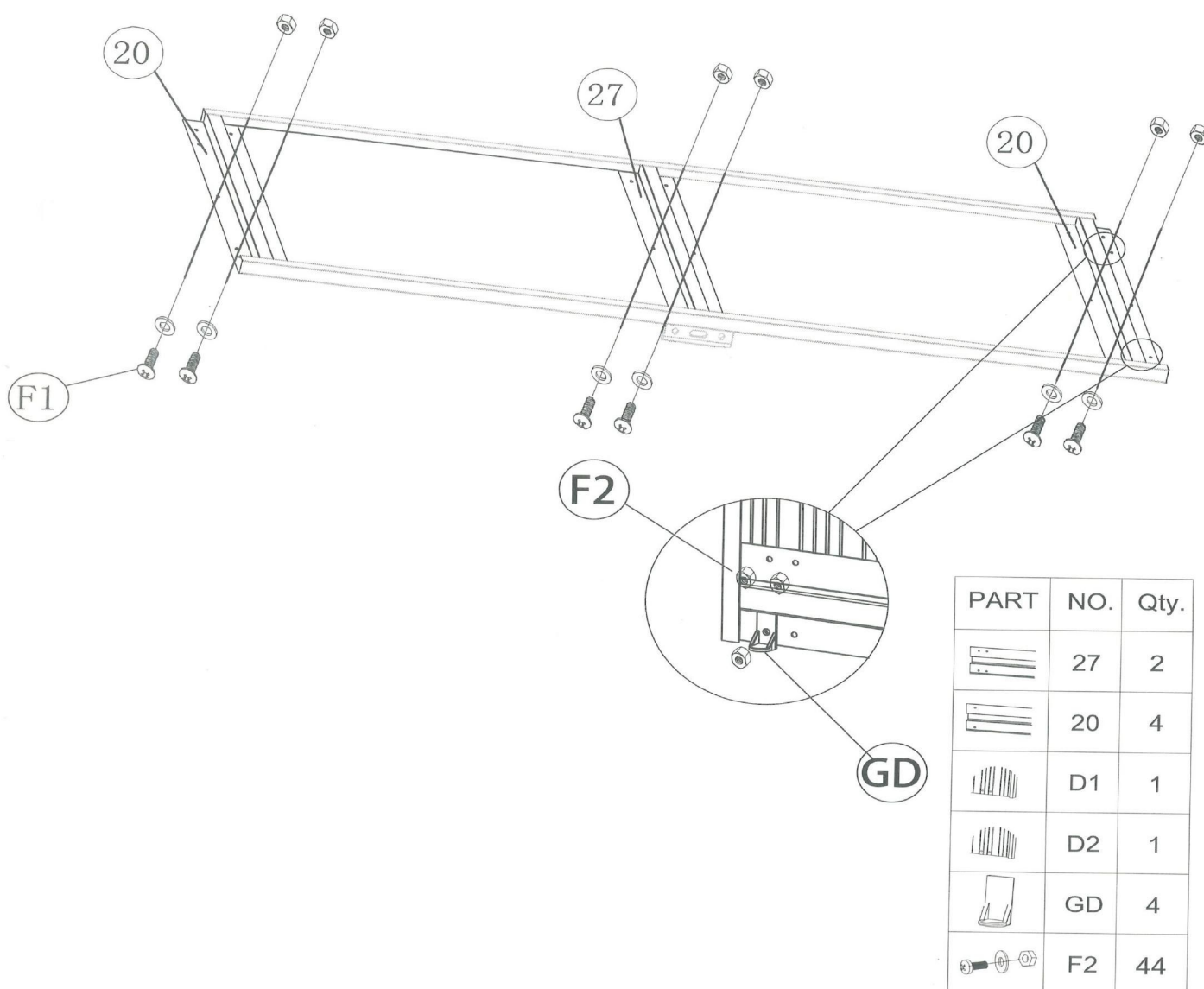

Pripevnite 2 kusy dverovej kľučky D2 zvnútra k dverným panelom pomocou skrutky F2 a matice.

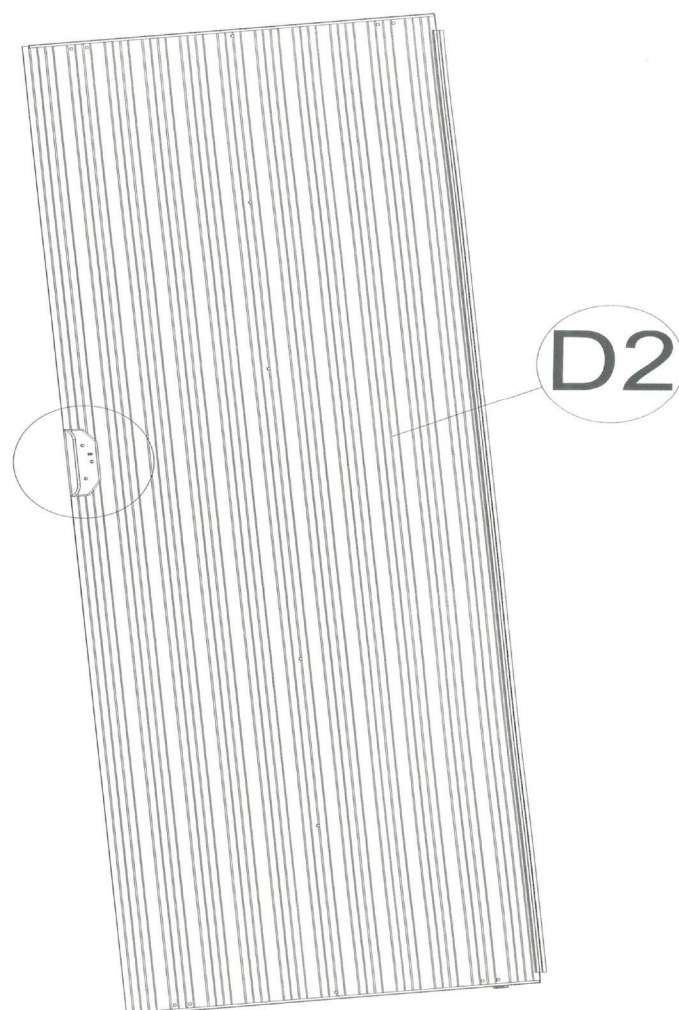
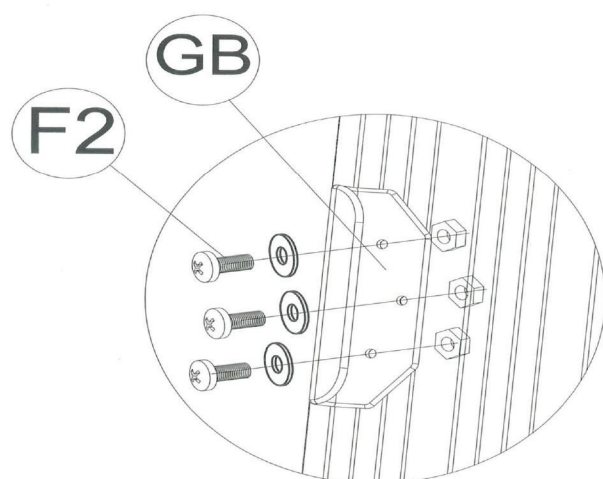

PART	NO.	Qty.
	GB	2
	F2	6

Zasuňte zostavu dverného panelu do základnej tyče 3L. Uistite sa, že spodný posúvač GD sa posúva vo vnútri 3L základnej tyče. Potom pripevnite hornú časť dverného panelu k hornému posúvaču G2 pomocou skrutiek F3.

Uistite sa, že dvierka správne zapadajú pre otvory pre dverný panel.

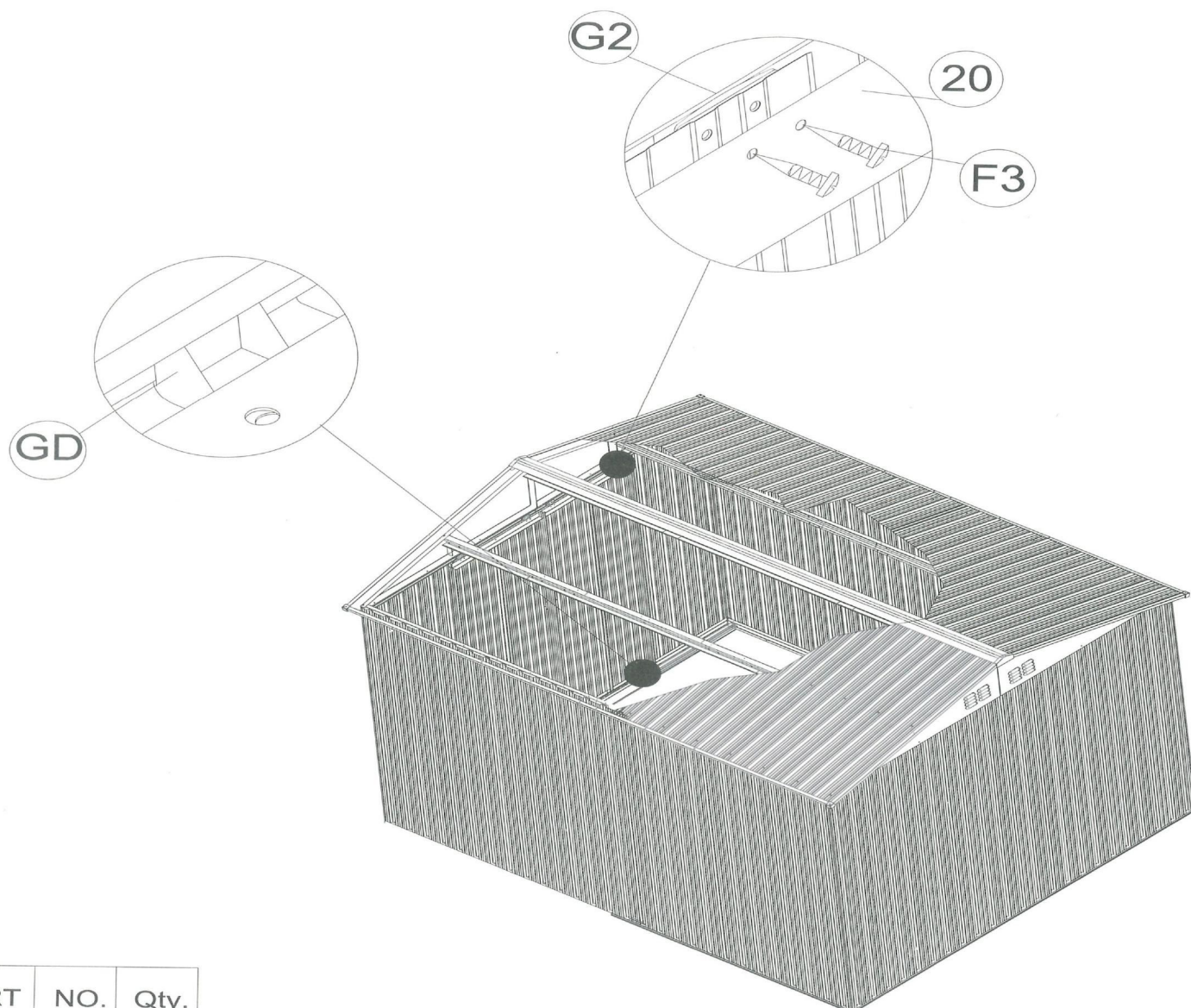

PART	NO.	Qty.
	F3	8